



# STRAP CLAMP



## Model:

- #10105 Corner wing set X4
- #10106 5 metre strap clamp kit
- #10107 9 metre strap clamp kit
- #10108 5 metre strap only
- #10109 9 metre strap only

## Description:

The steel strap and powerful locking system mean that large and heavy frames can be clamped tightly together. The band is stainless steel with flexible plastic corners, ensuring that the outside edge of the frame will not be damaged. The Strap Clamp also has the advantage that you can see the corners altogether before V-Nailing and there is no limit to the size of the moulding which can be joined. Suitable for joining 4, 6, 8 and 10-sided frames.



Hobby work



Multi-sided frames



Chairs, furniture etc.



Clamping large objects



Round objects

# STRAP CLAMP INSTRUCTION MANUAL

## Installation of Corner Wings

1. Your FrameCo clamp also comes with the new corner "wings". These wings fit onto the bottom of each corner piece, preventing the clamp from slipping off the frame. Fit the corner wings when joining rounded or narrow-backed mouldings. Remove the wings for moving the corner piece higher up the moulding.
2. The groove running through the centre of the corner piece is also useful on some mouldings which have a stepped back. Position the corner piece so that the groove is located on a ridge or outside edge of the moulding.
3. It may be advisable to fit one extra flexible corner to the strap, if the frame profile is difficult to clamp; then the fixed 90° corner of the clamp head can be moved to the centre of one side. The strap will hold the head away from the side so that it will not mark the frame side.

The clamp can be tightened in the normal way.

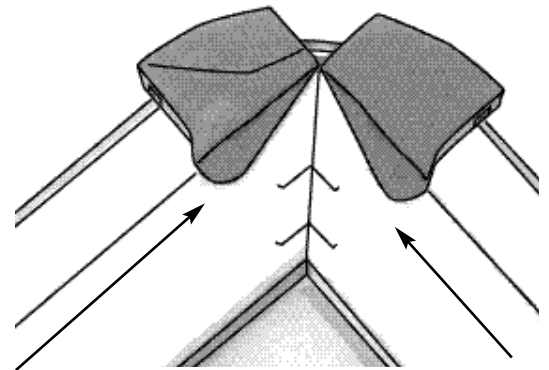

Fit wings when joining rounded back frames

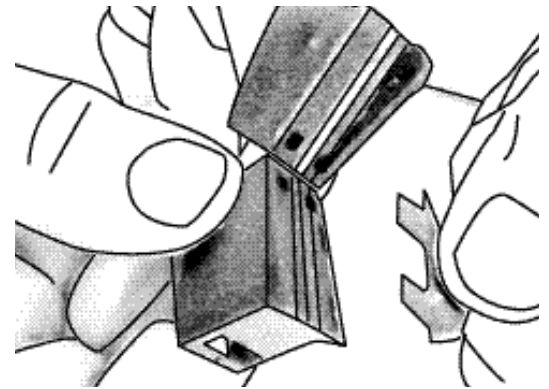

Press fit wing into slots

## Replacement Parts

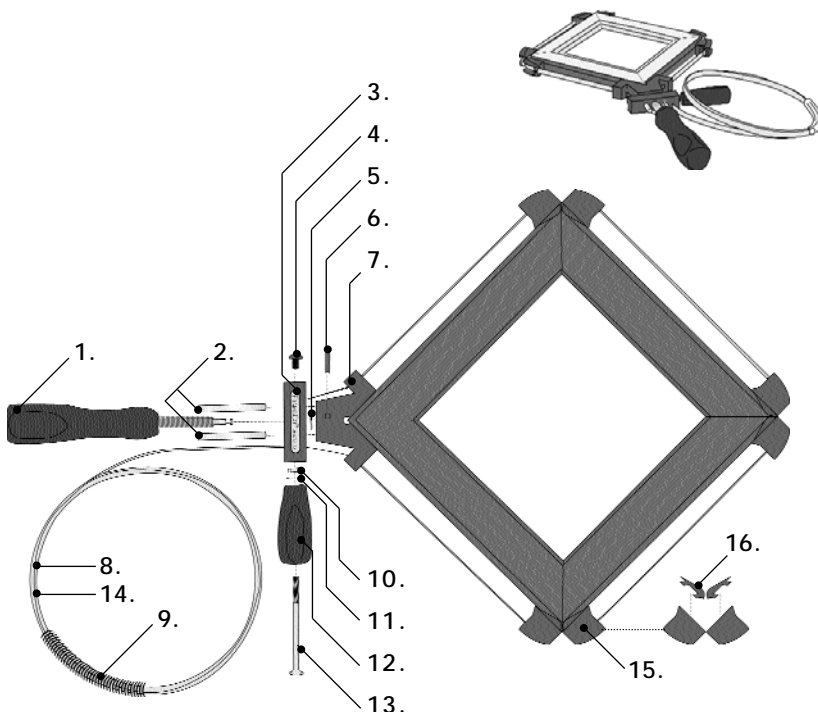

### Steel Strap Clamp

1. #72000 Main Adjustment Handle & Spindle
2. #72001 Dowel Pins
3. #72002 Locking Block
4. #72003 Button Head Screw
5. #72004 Washer
6. #72005 Roll Pin
7. #72006 Vee Block
8. #72007 Steel Strap 5m (16')
9. #72008 Stainless Steel Spring
10. #72009 Locking Nut
11. #72010 Washer
12. #72011 Locking Handle
13. #72012 Bolt
14. #72013 Steel Strap 9m (29')
15. #72014 Corner Pieces
16. #72015 Corner Wings

# STRAP CLAMP INSTRUCTION MANUAL

## How to use the Strap Clamp

1. It is important that the corners of the frame you intend to join are held firmly together before V-Nailing. The pressure of the V-Nail entering the base of the moulding can force the joint to open, if the frame is not held securely. For this purpose, the FrameCo HobbiClamp or Steel Strap Clamp are ideal. Glue on all joints is also recommended.
2. Lay out the frame to be joined face upwards on to a flat surface and position the Strap Clamp around the frame with the locking handle to the right-hand side.
3. The clamp is easier to use if you slide the frame and the clamp to the edge of the bench. Pull through the excess strap, then lock the strap by tightening the right-hand locking handle.
4. Slide the frame and clamp back on to the bench and align each of the joints. Apply further pressure by tightening the central tensioning handle a few turns. Check the alignment of the joints again, then apply more pressure with a few more turns of the central tensioning handle. Repeat the process until the band is tight.
5. Once the frame is tight and secure in the clamp, carefully turn over the frame and insert V-Nails in each corner to join the frame.

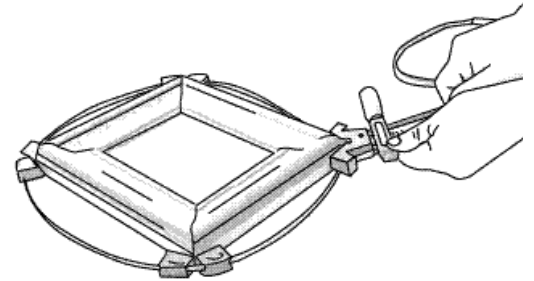

Place the steel strap around the frame and secure with locking handle

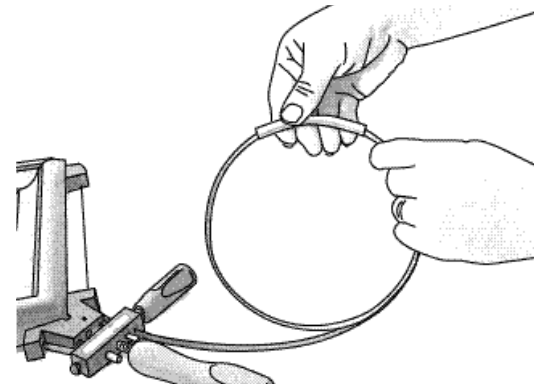

Wind-out and wind-up the steel strap by moving the spring.

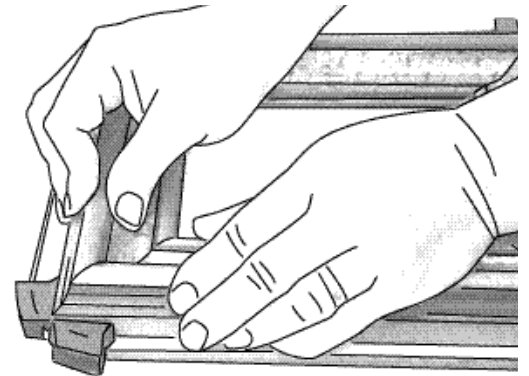



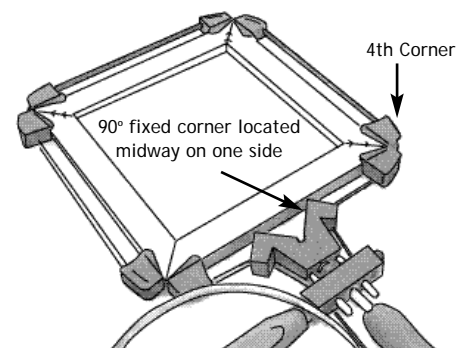









Align the corners together before tightening.

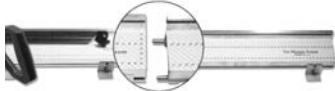

Add the fourth corner - the 90° fixed corner is located midway on one side

*...just like a professional*

Also available from FrameCo, a complete range of quality tools for professional picture framing.

MAT CUTTING	FRAME CUTTING	FRAME CLAMPING	FRAME JOINING
 <p><b>Ruler Systems</b> Ideal for beginners Perfect bevel corners everytime</p> <ul style="list-style-type: none"> <li>• Easy grip handle</li> <li>• Glide strip</li> <li>• Retractable blade</li> <li>• Start/stop indicator line</li> <li>• No overcuts</li> </ul>	 <p><b>Chop Service</b> Ideal for beginners Mitre cut to length moulding</p> <ul style="list-style-type: none"> <li>• No risk of bad cuts</li> <li>• No worries about cutting</li> <li>• No storage - right amount</li> <li>• No wastage - less cost</li> <li>• Large variety of mouldings</li> </ul>	 <p><b>Cord Clamp</b> Ideal for beginners Uses a non-slip locking system</p> <ul style="list-style-type: none"> <li>• Non-scratch plastic corners</li> <li>• Non-slip corner "wings"</li> <li>• Clamp up to 60cm-24" square</li> <li>• Use with glue</li> <li>• V-nail after glue is dry</li> </ul>	 <p><b>EzyFramer</b> Ideal for beginners Non mechanical, hand operated</p> <ul style="list-style-type: none"> <li>• Joins hard and soft timbers</li> <li>• Inserts all sizes of V-Nails</li> <li>• Inserts backing nails</li> <li>• Durable impact proof handle</li> <li>• Unique patented system</li> </ul>
 <p><b>Baseboard Systems</b> Baseboard and lift on/off ruler</p> <ul style="list-style-type: none"> <li>• Border width scale</li> <li>• Production stop</li> <li>• Straight &amp; bevel cutters</li> <li>• Solid aluminum base</li> <li>• Start/stop indicator line</li> <li>• No overcuts</li> </ul>	 <p><b>Mitre Saws</b> Best saw to use is a combined mitre box and suspension saw</p> <ul style="list-style-type: none"> <li>• We recommend "Nobex"</li> <li>• Grooved base - compound cuts</li> <li>• Ideal for delicate mouldings</li> <li>• Accurate cuts everytime</li> <li>• Multi-angle cutting</li> </ul>	 <p><b>Hobbi Clamp</b> Hobbi clamp consists of the cord clamp combined with a tensioner</p> <ul style="list-style-type: none"> <li>• Tensioner reduces cord stretch</li> <li>• Non-scratch plastic corners</li> <li>• Non-slip corner "wings"</li> <li>• Clamp up to 60cm-24" square</li> <li>• Use glue, V-nail once dry</li> </ul>	 <p><b>PushMaster</b> Professional V-Nailing tool Hand or mechanically operated</p> <ul style="list-style-type: none"> <li>• Joins hard and soft timbers</li> <li>• Inserts all sizes of V-Nails</li> <li>• Inserts backing nails/flexipoints</li> <li>• Durable impact proof handle</li> <li>• Unique patented system</li> </ul>
 <p><b>Mounted Systems</b> These are the only DIY mat cutters to rival the professional machines</p> <ul style="list-style-type: none"> <li>• Hinged rail</li> <li>• Right hand squaring arm</li> <li>• Border width scale</li> <li>• Production stops</li> <li>• Straight &amp; bevel cutters</li> </ul>	 <p><b>Measuring Systems</b> Accurate lengths of moulding made quick and easy</p> <ul style="list-style-type: none"> <li>• Solid aluminium base</li> <li>• Easy storage - 2 sections</li> <li>• Non-slip rubber feet</li> <li>• Attaches to Proman "Nobex"</li> <li>• Accurate lengths everytime</li> </ul>	 <p><b>Corner Clamp</b> This clamp uses a unique front jaw which forces the joint together</p> <ul style="list-style-type: none"> <li>• Precision engineered aluminium</li> <li>• Single corner clamp</li> <li>• For large or complex mouldings</li> <li>• Ideal for frame restoration</li> <li>• Superior Clamping</li> </ul>	 <p><b>HobbiFramer</b> Professional V-Nailing tool Powerful mechanical operation</p> <ul style="list-style-type: none"> <li>• Joins hard and soft timbers</li> <li>• Inserts all sizes of V-Nails</li> <li>• Adjustable height</li> <li>• Solid aluminium base</li> <li>• Unique patented system</li> </ul>
 <p><b>Decorative &amp; Specialty</b> Add style to your framing</p> <ul style="list-style-type: none"> <li>• Bevelled circles &amp; arcs</li> <li>• Creative V-Grooving</li> <li>• Freehand bevel cutting</li> <li>• Embossed line work</li> <li>• Memorabilia - Shadow box</li> <li>• Deep cut bevels</li> </ul>	 <p><b>Guillotine / Trimmer</b> An ideal addition to any workshop</p> <ul style="list-style-type: none"> <li>• Solid, super sharp blades</li> <li>• Clean smooth cuts</li> <li>• Greatly reduces time &amp; cost</li> <li>• Cuts all timbers</li> <li>• Blades can be resharpened</li> <li>• Multi-angle trimming</li> </ul>	 <p><b>Strap Clamp</b> See all 4 corners clamped together before joining</p> <ul style="list-style-type: none"> <li>• Non-stretch stainless steel strap</li> <li>• Tight secure joints</li> <li>• Non-scratch plastic corners</li> <li>• Non-slip corner "wings"</li> <li>• Frame up to 125cm-4' square</li> </ul>	 <p><b>BenchMaster I, II &amp; III</b> Professional V-Nailing tool Powerful mechanical operation</p> <ul style="list-style-type: none"> <li>• Upgrade your PushMaster</li> <li>• Joins hard and soft timbers</li> <li>• Inserts all sizes of V-Nails</li> <li>• Inserts backing nails/flexipoints</li> <li>• Unique patented system</li> </ul>

[www.clubframeco.com](http://www.clubframeco.com)

FrameCo - Australia  
20 Joseph Street  
North Blackburn VIC 3130  
Freecall: 1800 033 619  
Ph: 03 9843 1900  
Email: [frame@frameco.com.au](mailto:frame@frameco.com.au)

FrameCo U.K. Ltd.  
Unit 1 East 41 Garside Way Stocklake  
Aylesbury, Bucks UK HP20 1BH  
Freecall: 0800 389 0767  
Ph: 01296 399 860  
Email: [info@clubframeco.co.uk](mailto:info@clubframeco.co.uk)

FrameCo U.S.A. Inc.  
3850 Ramada Drive D-1  
California USA 93446  
Freecall: 800 682 1222  
Ph: 805 434 0912  
Email: [info@frameco-usa.com](mailto:info@frameco-usa.com)